

XUECONcare

Mobile Field Assistant

- 7" 500 cd/m² TFT LCD with projective capacitive touchscreen
- Texas Instruments Sitara ARM Cortex A8 CPU
- Powered by Android 2.3.4 OS
- 1D laser / 2D imager scan engine, HF RFID reader
- Dual Camera :
2 Megapixels CMOS front camera
5 Megapixels CMOS rear camera
- Bluetooth, Wi-Fi, 3.5G wireless
- Built-in Ublox GPS with internal antenna
- Dual hot swappable batteries

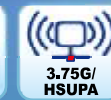

Field Service Application

1
XUECON Solutions

Increase field service productivity and efficiency with XUECONCARE Mobile Field Assistant. This RISC-based tablet PC features TI OMAP3 AM3715 CPU and runs on the Android 2.3.4 OS. Targeted for field service applications, it can be used for:

- Capturing and recording information in real-time
- Determining customers' locations
- Tracking and locating mobile field workers
- Accessing and updating information in real-time

2
Optional Panel Solutions



Track and Locate

3
RISC-based clients



Capture and Record

4
Centralized Mobile Client



Access and Update

5
Optional peripherals



Power Saving and Trendy Platform

TI Cortex A8 CPU

- TI's Sitara family of highly-integrated ARM9™ and ARM Cortex™-A8 microprocessor portfolio offers various combinations of high-performance and low power levels, providing the ability to create an array of products using a common hardware and software platform.
- Reduce system risks and accelerate time to market using standard and comprehensive ARM-based software development tools.
- TI is the largest ARM core licensee supporting all major high-level operating systems such as Android and Windows CE.

Sitara™ offers

Performance

- Up to 450MHz ARM9 to 1.5GHz Cortex A8 devices
- Industry's first widely available Cortex-A8 devices - 2DMIPS per MHz
- Graphics acceleration up to 27M polygons/s performance for advanced user interface
- High speed DDR2 and DDR3 memory performance

Connectivity

- 10/100/1000 Ethernet
- CAN 2.0 and high speed USB interface
- Multiple serial port options per device
- Cost effective** processor with SATA interface
- Flexible LCD controller for up to 720p displays and moving to 1080p in future devices
- Industrial peripheral support

AM3517/05 Cortex™ -A8 based processors

Benefit

- Support OS such as Linux, Win CE, RTOS
- 10M polygons/second for robust GUIs
- Multi windows overlay for hardware accelerated user

Power

- Total Power: L700mW
- Standby Power: 12mW

Suggested Application

- Industrial/Home automation
- Point of service

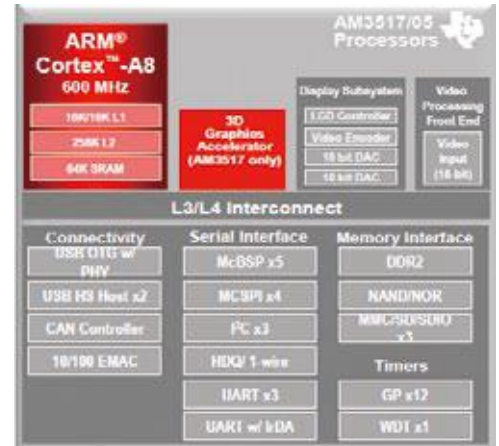

Android 2.3.4 Operating System

- Android is an operating system for mobile devices such as smartphones and tablet computers. It is developed by the Open Handset Alliance led by Google.
- Android was listed as the best-selling smartphone platform worldwide in Q4 2010 by Canals with over 200 million Android devices in use by November 2011.
- 2.3 Gingerbread refined the user interface, improved the soft keyboard and copy/paste features, improved gaming performance, added SIP support (VoIP calls), and added support for Near Field Communication.

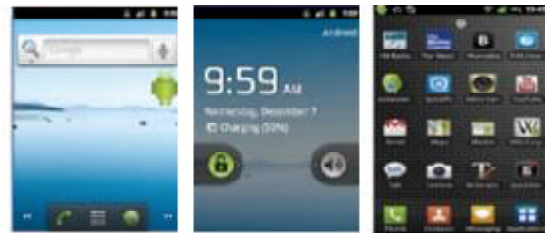

Android Security Issue:
Android applications run in a sandbox, an isolated area of the operating system that does not have access to the rest of the system's resources, unless access permissions are granted by the user when the application is installed. Before installing an application, Android Market displays all required permissions.

Seamless Wireless Communication

XUECONCARE keeps mobile workers connected with the back-office and peripherals through built-in 3.5G, Wi-Fi, and Bluetooth wireless technologies.

Local-Area Communication



Compliant with the 802.11 b/g/n. This feature allows fast data transfer for near field or ad-hoc data communication.

Wide-Area Mobile Communication



With up to 3.5G wireless technology, outfield workers can maintain and share constant contact with the back office.

Peripheral Communication



Compliant with the Bluetooth 2.1+EDR specification. This feature ensures easy and quick access to nearby peripherals.

Built-in Navigation Grade GPS module



GPS is a mature technology that allows users to locate their current location and other landmarks. Navigation and Positioning support

Advanced Data Collection Technology

2 Megapixels CMOS Camera

The optional 2 megapixels CMOS front camera functions as a web camera allowing field technicians to communicate face-to-face with the staffs in the office and other parties while on the move.

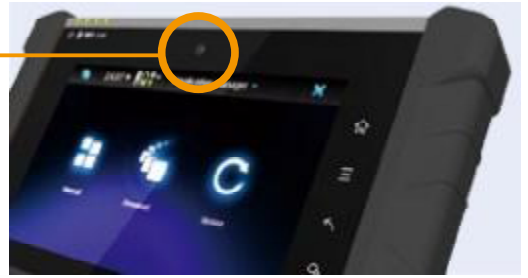

13.56 MHz RFID Reader

Support Read/Write, ISO 14443A (Mifare), ISO 14443B (Felica), ISO 15693. Support NFC Read/Write and peer-to-peer communication.

5 Megapixels CMOS Camera

The 5 megapixels CMOS rear camera can be used to capture environmental information while field technicians are performing services.



1D Laser / 2D Imager Scan Engine

The variety of barcode symbologies supported by the 1D laser / 2D imager scan engine allows easy and fast data capture, and thereby optimize work efficiency.

Efficient Power Management

XUECONCARE comes along with two battery packs that provides 11.1V 1880mAh capacity and support hot swappable function. When one battery is removed, the system automatically switches power consumption to the other battery. This design is beneficial for mobile field workers because:

- When power is running low, the batteries can be replaced with fully charged ones without shutting down the system and applications.
- With an additional battery pack, the device can operate for hours to ensure non-stop customer service.

Each battery pack has capacity indicators showing remaining power.

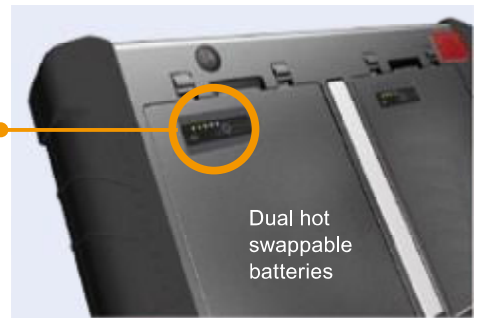

Dual hot swappable batteries

1

XUECON Solutions

2

Optional Panel Solutions

3

RFID-based clients

4

Optional Mobile clients

5

Optional peripherals



Rugged Design

Designed specifically for out-field applications, XUECONCARE has been tested and approved for its semi-ruggedness.



IP 64 Rating

Dust tight and protected against water splashed against the component from any direction



Operating Temperature -10°C ~ 40°C

It can be operated under a wide range of temperatures



1.2M Drop Test

Passed the 1.2M drop test on all sides 26 times



Storage Temperature -10°C ~ 60°C

It can be stored under extreme temperatures



A black protective rubber surrounds three sides of XUECONCARE, giving it the protection it needs in harsh work environments.

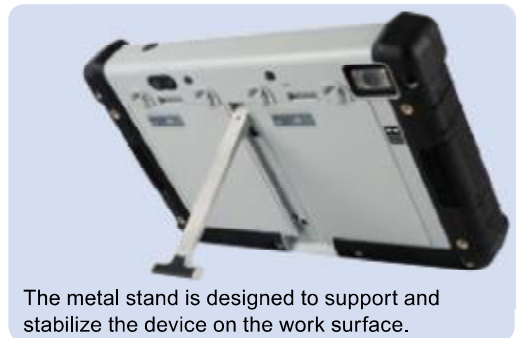

The metal stand is designed to support and stabilize the device on the work surface.

How Tough is Rugged?

Mobile computing devices, namely tablet PCs and industrial PDAs, are becoming increasingly popular for out-field use. Their versatility makes them useful in public safety and field service applications. However, popular consumer tablets or handhelds are not designed to meet outdoor use, especially where the environment is tough. They are not designed to work in the rain, or extreme hot or cold temperatures, or in areas where dust and dirt could interfere with the device. For these environments, tougher devices are required – those that meet the “rugged” standard.

So, what defines “rugged”? From the user’s perspective, rugged refers to the device’s ability to operate in the work environment that it is exposed to. However, different users work in different environments. Hence, rugged means something slightly different from one user to the other. For example, a tablet PC used in a warehouse will be more likely exposed to dust and drops, but will less likely be used in extreme temperatures. To meet the needs of all possible users, the industry has agreed upon a general a set of standards to test for a device’s ruggedness. These standards include tests for: extreme operating and storage temperatures, Ingress Protection (IP Grade) as well as drop survival.

XUECONCARE Mobile Field Assistant is compliant with IP 64 grade protection and has been tested with 1.2M drop tests on all sides of the device. It also features wide operating and storage temperature ranges. Taken these together, XUECONCARE complies with the “rugged” standard and ensures stable operation under tough environments.



Drop Survival

Protection against accidental drops.



IP Grade

Protection against dust and water splash.



Operating Temperature

Protection against extreme temperatures.

Specifications

Model	XUECONCARE					
Display	LCD Size	7" TFT LCD	Indicators & Buttons	LED Indicators	Charging Status LED (Orange / Green) Wi-Fi enable / disable LED (Green) BT enable / disable LED (Blue) 3.5G enable / disable LED (Green) Power on/off switch	
	Brightness (cd/m ²)	500 cd/m ²		Keys	Reset Key	Reset Key
	Max Resolution	800 (H) x 480 (V)			4 x Function key (Home / Menu / Back / Search)	
	Viewing Angle	60/70/70/70 Deg.				
	Touch Screen	Projective capacitive type				
System	CPU	TI Sitara AM3715	I/O Interface	Audio	1 x Headset 1 x 1.5W speaker	
	OS	Android 2.3.4		Expansion	1 x Digital Mic	
	Memory	4GB eMMC Flash + 512MB SDRAM			2 x USB 2.0	
	Storage	SD Slot		1 x DC Jack		
Communication	Wireless LAN	Wi-Fi 802.11 b/g/n	Docking (Support Wall Mount)	1 x Ethernet 10/100M		
	Bluetooth	Bluetooth 2.1+EDR		1 x Full Function RS-232		
	Modem	HSUPA/GPRS/GSM		1 x 1.5W speaker		
	GPS	GPS with internal antenna	2 x USB 2.0			
	RFID	HF RFID ISO 14443A(Mifare) ISO 14443B(Felica) ISO 15693 NFC		1 x DC Jack		
				Power Adapter	19V @ 2.1A @ 40W	
				Battery	Dual 11.1V 1880mAh Li-ion battery	
Environment			Operating Temperature	-10°C ~ 40°C		
			Storage Temperature	-10°C ~ 60°C		
			Humidity	5%~95% non-condensing		
			Drop Survival	1.2 M		
			Environment Protection	IP64		
Data Collection	Barcode	1D laser/2D imager scan engine	Certification	CE / FCC		
	Camera (Back)	5 megapixels CMOS camera	Physical Characteristics	Dimensions (LxWxH) (mm)	248 x 153 x 36	
	Camera (Front)	2 megapixels CMOS camera		Weight	0.95 kg	

Ordering Information

Part No.	Description
XUECONCARE-07-R10	7" TFT-LCD industrial tablet with TI Sitara AM3715 CPU, HSUPA/GPRS/GSM, WiFi/Bluetooth, GPS, RFID, 2D/1D barcode, 2M/5M Camera, Android 2.3 OS, RoHS
XUECONCARE-07-1D-R10	7" TFT-LCD industrial tablet with TI Sitara AM3715 CPU, WiFi/Bluetooth, 1D barcode, 2M/5M Camera, Android 2.3 OS, RoHS

Packing List

Item	Part No.	Q'ty
Battery Pack	31603-000016-RS	1
Power Adapter	63040-290040-000-RS	1

Model Variations

Part No.	WiFi	Bluetooth	Modem	GPS	Barcode	RFID
XUECONCARE-07-R10	802.11 b/g/n	Ver 2.1 +EDR	HSUPA/GPRS/GSM	GPS	1D/2D	HF RFID
XUECONCARE-07-1D-R10	802.11 b/g/n	Ver 2.1 +EDR	N/A	N/A	1D	N/A

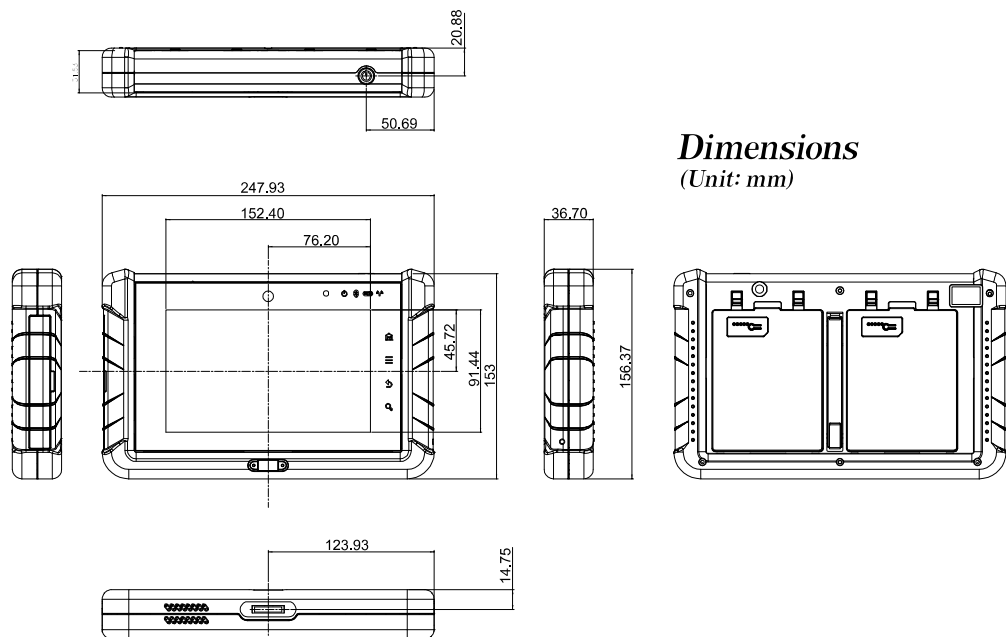

Dimensions
(Unit: mm)

1

XUECON Solutions

2

Automation Panel Solutions

3

RFID-based solutions

4

Control Panel Solutions

5

Optional peripherals